

RM-Kern RM 5 - low profile
RM core RM 5 - low profile

Magn. Formkenngrößen/Satz
eff. magn. parameters/set

Formfaktor <i>core factor</i>	$C_1 =$	0,71 mm ⁻¹
Eff. magn. Weglänge <i>eff. magn. path length</i>	$l_e =$	17,5 mm
Eff. magn. Querschnitt <i>eff. magn. cross section</i>	$A_e =$	24,5 mm ²
Min. magn. Querschnitt <i>min. magn. cross section</i>	$A_{min} =$	18,0 mm ²
Eff. magn. Volumen <i>eff. magn. volume</i>	$V_e =$	430 mm ³
Gewicht <i>weight</i>	$G \approx$	2 g

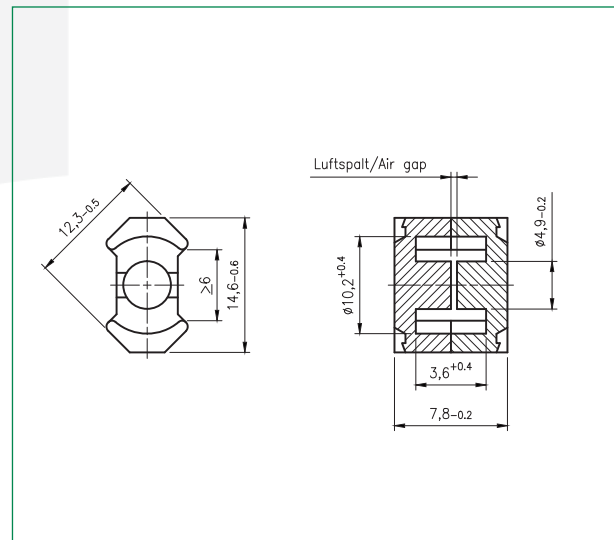

Werkstoff <i>material</i>	A_L -Wert A_L value nH	Toleranz <i>tolerance</i>	Luftspalt <i>airgap</i> mm	μ_e	Bestellnummer <i>order number</i>
K 2001	1850	± 25%	-	≈ 1050	373 050000 221
K 2006	2550	± 25%	-	≈ 1440	373 050000 026
K 2008	2700	± 25%	-	≈ 1530	373 050000 028

Bei Anwendung in Leistungsübertragern
for application in power transformers

Werkstoff <i>material</i>	Messbedingungen <i>test conditions</i>	Verluste/Satz <i>losses/set</i>
K 2001	500kHz, 50mT, 100°C	≤ 0,07 W
K 2006	25kHz, 200mT, 100°C	≤ 0,05 W
K 2008	100kHz, 200mT, 100°C	≤ 0,21 W

All information given without liability. If you require further information about our products, do not hesitate to contact our representatives, or visit our homepage, www.kaschke.de.

Kaschke Components GmbH

Rudolf-Winkel-Straße 6 · 37079 Göttingen · Germany
 Fon +49 (0) 5 51-50 58-6 · Fax +49 (0) 5 51-65 75 6
 kaschke.de